

IGBT Modules

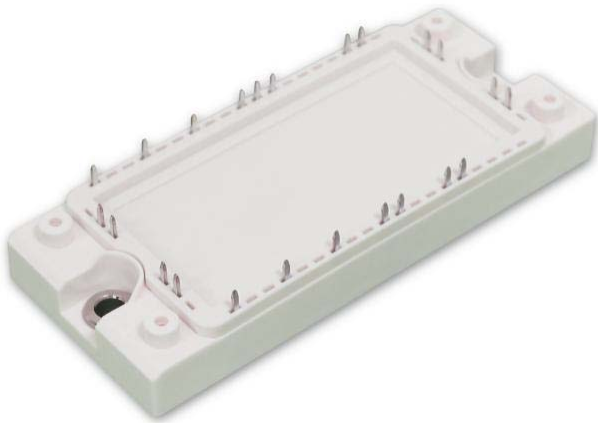

V_{CES} 1200V
 I_C 50A

Applications

- Motor Drivers
- AC and DC servo drive amplifier
- UPS (Uninterruptible Power Supplies)

Features

- Low switching losses
- Low $V_{ce(sat)}$ with positive temperature coefficient
- Including fast & soft recovery anti-parallel FWD
- Low inductance case
- High short circuit capability(10us)
- Maximum junction temperature 175°C

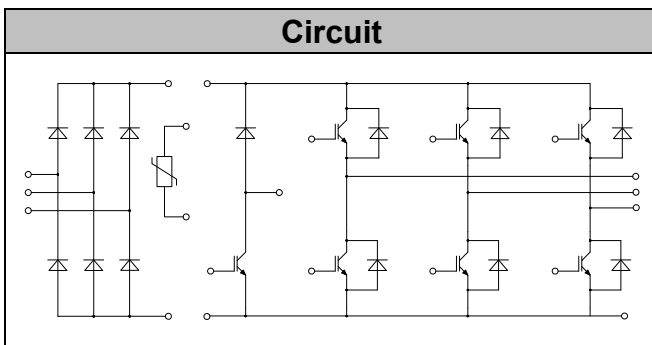

● IGBT- inverter

Absolute Maximum Ratings

Parameter	Symbol	Conditions	Value	Unit
Collector-Emitter Voltage	V_{CES}	$V_{GE}=0V, I_C=1mA, T_{vj}=25^{\circ}C$	1200	V
Continuous Collector Current	I_C	$T_c=100^{\circ}C, T_{vjmax}=175^{\circ}C$	50	A
Repetitive Peak Collector Current	I_{CRM}	$tp=1ms$	100	A
Gate-Emitter Voltage	V_{GES}	$T_{vj}=25^{\circ}C$	± 20	V
Total Power Dissipation	P_{tot}	$T_c=25^{\circ}C$ $T_{vjmax}=175^{\circ}C$	288	W



● IGBT- inverter

Characteristic values

Parameter	Symbol	Conditions	Value			Unit	
			Min.	Typ.	Max.		
Gate-emitter Threshold Voltage	$V_{GE(th)}$	$V_{GE}=V_{CE}, I_C=2.0mA, T_{vj}=25^{\circ}C$	5.2	5.8	6.4	V	
Collector-Emitter Cut-off Current	I_{CES}	$V_{CE}=1200V, V_{GE}=0V, T_{vj}=25^{\circ}C$			1.0	mA	
Collector-Emitter Saturation Voltage	$V_{CE(sat)}$	$I_C=50A, V_{GE}=15V, T_{vj}=25^{\circ}C$		1.90	2.30	V	
		$I_C=50A, V_{GE}=15V, T_{vj}=125^{\circ}C$		2.30			
		$I_C=50A, V_{GE}=15V, T_{vj}=150^{\circ}C$		2.40			
Gate Charge	Q_G			0.35		uC	
Input Capacitance	C_{ies}	$V_{CE}=25V, V_{GE}=0V,$ $f=1MHz, T_{vj}=25^{\circ}C$		2.60		nF	
Reverse Transfer Capacitance	C_{res}			0.10		nF	
Gate-Emitter leakage current	I_{GES}	$V_{CE}=0V, V_{GE}=20V, T_{vj}=25^{\circ}C$			400	nA	
Turn-on Delay Time	$t_{d(on)}$	$I_C=50A$ $V_{CE}=600V$ $V_{GE}=\pm 15V$ $R_G=15\Omega$ $T_{vj}=25^{\circ}C$		168		ns	
Rise Time	t_r			34		ns	
Turn-off Delay Time	$t_{d(off)}$			320		ns	
Fall Time	t_f			78		ns	
Energy Dissipation During Turn-on Time	E_{on}			5.42		mJ	
Energy Dissipation During Turn-off Time	E_{off}			4.15		mJ	
Turn-on Delay Time	$t_{d(on)}$		$I_C=50A$ $V_{CE}=600V$ $V_{GE}=\pm 15V$ $R_G=15\Omega$ $T_{vj}=125^{\circ}C$		175		ns
Rise Time	t_r				42		ns
Turn-off Delay Time	$t_{d(off)}$				426		ns
Fall Time	t_f			148		ns	
Energy Dissipation During Turn-on Time	E_{on}			7.26		mJ	
Energy Dissipation During Turn-off Time	E_{off}			5.80		mJ	
SC Data	I_{sc}	$T_p \leq 10\mu s, V_{GE}=15V, T_{vj}=150^{\circ}C,$ $V_{cc}=900V, V_{CEM} \leq 1200V$			260		A



● Diode-inverter

Absolute Maximum Ratings

Parameter	Symbol	Conditions	Value	Unit
Repetitive Peak Reverse Voltage	V_{RRM}	$T_{vj}=25^{\circ}C$	1200	V
Continuous DC Forward Current	I_F		50	A
Repetitive Peak Forward Current	I_{FRM}	$t_p=1ms$	100	A
I^2t -value	I^2t	$V_R=0, t_p=10ms, T_{vj}=125^{\circ}C$	560	A ² s
		$V_R=0, t_p=10ms, T_{vj}=150^{\circ}C$	480	

Characteristic values

Parameter	Symbol	Conditions	Value			Unit
			Min.	Typ.	Max.	
Forward Voltage	V_F	$I_F=50A, T_{vj}=25^{\circ}C$		1.95	2.50	V
		$I_F=50A, T_{vj}=125^{\circ}C$		1.80		
		$I_F=50A, T_{vj}=150^{\circ}C$		1.70		
Recovered Charge	Q_{rr}	$I_F=50A$		5.8		μC
Peak Reverse Recovery Current	I_{rr}	$V_R=600V$ $-di_F/dt=1500A/\mu s$		56		A
Reverse Recovery Energy	E_{rec}	$T_{vj}=25^{\circ}C$		1.85		mJ
Recovered Charge	Q_{rr}	$I_F=50A$		9.1		μC
Peak Reverse Recovery Current	I_{rr}	$V_R=600V$ $-di_F/dt=1500A/\mu s$		58		A
Reverse Recovery Energy	E_{rec}	$T_{vj}=125^{\circ}C$		3.30		mJ



● **IGBT-brake-chopper**
Absolute Maximum Ratings

Parameter	Symbol	Conditions	Value	Unit
Collector-Emitter Voltage	V_{CES}	$V_{GE}=0V, I_C=1mA, T_{vj}=25^{\circ}C$	1200	V
Continuous Collector Current	I_C	$T_c=100^{\circ}C, T_{vjmax}=175^{\circ}C$	35	A
Repetitive Peak Collector Current	I_{CRM}	$t_p=1ms$	70	A
Gate-Emitter Voltage	V_{GES}	$T_{vj}=25^{\circ}C$	± 20	V
Total Power Dissipation	P_{tot}	$T_c=25^{\circ}C$ $T_{vjmax}=175^{\circ}C$	227	W

Characteristic values

Parameter	Symbol	Conditions	Value			Unit
			Min.	Typ.	Max.	
Gate-emitter Threshold Voltage	$V_{GE(th)}$	$V_{GE}=V_{CE}, I_C=1.4mA, T_{vj}=25^{\circ}C$	5.2	6.0	6.8	V
Collector-Emitter Cut-off Current	I_{CES}	$V_{CE}=1200V, V_{GE}=0V, T_{vj}=25^{\circ}C$			1.0	mA
Collector-Emitter Saturation Voltage	$V_{CE(sat)}$	$I_C=35A, V_{GE}=15V, T_{vj}=25^{\circ}C$		1.90	2.30	V
		$I_C=35A, V_{GE}=15V, T_{vj}=125^{\circ}C$		2.20		
		$I_C=35A, V_{GE}=15V, T_{vj}=150^{\circ}C$		2.30		
Gate Charge	Q_G			0.27		μC
Input Capacitance	C_{ies}	$V_{CE}=25V, V_{GE}=0V,$ $f=1MHz, T_{vj}=25^{\circ}C$		2.00		nF
Reverse Transfer Capacitance	C_{res}			0.07		nF
Gate-Emitter leakage current	I_{GES}	$V_{CE}=0V, V_{GE}=20V, T_{vj}=25^{\circ}C$			400	nA
Turn-on Delay Time	$t_{d(on)}$	$I_C=35A$ $V_{CE}=600V$ $V_{GE}=\pm 15V$ $R_G=12\Omega$ $T_{vj}=25^{\circ}C$		25		ns
Rise Time	t_r			13		ns
Turn-off Delay Time	$t_{d(off)}$				124	ns
Fall Time	t_f				115	ns
Energy Dissipation During Turn-on Time	E_{on}				1.90	mJ
Energy Dissipation During Turn-off Time	E_{off}				2.00	mJ



Turn-on Delay Time	$t_{d(on)}$	$I_C = 35\text{ A}$ $V_{CE} = 600\text{ V}$ $V_{GE} = \pm 15\text{ V}$ $R_G = 12\Omega$ $T_{vj} = 125^\circ\text{C}$	38	ns
Rise Time	t_r		21	ns
Turn-off Delay Time	$t_{d(off)}$		178	ns
Fall Time	t_f		170	ns
Energy Dissipation During Turn-on Time	E_{on}		2.90	mJ
Energy Dissipation During Turn-off Time	E_{off}		2.90	mJ
SC Data	I_{sc}		$T_p \leq 10\mu\text{s}, V_{GE} = 15\text{ V}, T_{vj} = 150^\circ\text{C},$ $V_{cc} = 900\text{ V}, V_{CEM} \leq 1200\text{ V}$	150

● Diode-Brake-Chopper

Absolute Maximum Ratings

Parameter	Symbol	Conditions	Value	Unit
Repetitive Peak Reverse Voltage	V_{RRM}	$T_j = 25^\circ\text{C}$	1200	V
Continuous DC Forward Current	I_F		15	A
Repetitive Peak Forward Current	I_{FRM}	$t_p = 1\text{ ms}$	30	A
I^2t -value	I^2t	$V_R = 0, t_p = 10\text{ ms}, T_j = 125^\circ\text{C}$	48.0	A ² s
		$V_R = 0, t_p = 10\text{ ms}, T_j = 150^\circ\text{C}$	42.0	

Characteristic values

Parameter	Symbol	Conditions	Value			Unit
			Min.	Typ.	Max.	
Forward Voltage	V_F	$I_F = 15\text{ A}, T_{vj} = 25^\circ\text{C}$		1.95		V
		$I_F = 15\text{ A}, T_{vj} = 125^\circ\text{C}$		1.80		
		$I_F = 15\text{ A}, T_{vj} = 150^\circ\text{C}$		1.70		
Recovered Charge	Q_{rr}	$I_F = 15\text{ A}$		1.10		μC
Peak Reverse Recovery Current	I_{rr}	$V_R = 600\text{ V}$ $-di_F/dt = 550\text{ A}/\mu\text{s}$		12.0		A
Reverse Recovery Energy	E_{rec}	$T_{vj} = 25^\circ\text{C}$		0.30		mJ
Recovered Charge	Q_{rr}	$I_F = 15\text{ A}$		1.90		μC
Peak Reverse Recovery Current	I_{rr}	$V_R = 600\text{ V}$ $-di_F/dt = 550\text{ A}/\mu\text{s}$		14.0		A
Reverse Recovery Energy	E_{rec}	$T_{vj} = 125^\circ\text{C}$		0.60		mJ



● Diode-Rectifier

Absolute Maximum Ratings

Parameter	Symbol	Conditions	Value	Unit
Repetitive Peak Reverse Voltage	V_{RRM}	$T_j=25^{\circ}\text{C}$	1600	V
Average output Current 50/60Hz, sine wave	$I_{F(AV)}$	$T_c=100^{\circ}\text{C}$	50	A
Maximum RMS Current at Rectifier Output	I_{RMSM}	$T_c=100^{\circ}\text{C}$	100	A
Surge Forward Current	I_{FSM}	$V_R=0, t_p=10\text{ms}, T_j=45^{\circ}\text{C}$	525	A
I^2t -value	I^2t	$V_R=0, t_p=10\text{ms}, T_j=45^{\circ}\text{C}$	1378	A^2s

Characteristic values

Parameter	Symbol	Conditions	Value			Unit
			Min.	Typ.	Max.	
Diode Forward Voltage	V_F	$I_F=50\text{A}, T_j=125^{\circ}\text{C}$		1.0		V
Reverse Current	I_R	$T_j=125^{\circ}\text{C}, V_R=1600\text{V}$			1.5	mA

● NTC-Thermistor

Characteristic values

Parameter	Symbol	Conditions	Value			Unit
			Min.	Typ.	Max.	
Rated Resistance	R_{25}			5.0		$\text{k}\Omega$
Deviation of R100	$\Delta R/R$	$T_c=100, R_{100}=493.3\Omega$	-5		5	%
Power Dissipation	P_{25}				20.0	mW
B-value	$B_{25/50}$	$R_2=R_{25}\exp[B_{25/50}(1/T_2-1/(298.15\text{K}))]$		3375		K



● Module Characteristics

$T_C=25^\circ\text{C}$ unless otherwise specified

Parameter	Symbol	Conditions	Value			Unit
			Min.	Typ.	Max.	
Isolation voltage	V_{isol}	$t=1\text{min}, f=50\text{Hz}$	2500			V
Maximum Junction Temperature	T_{jmax}				175	$^\circ\text{C}$
Operating Junction Temperature	T_{vjop}		-40		150	$^\circ\text{C}$
Storage Temperature	T_{stg}		-40		125	$^\circ\text{C}$
Stray-inductance-module	L_{SCE}			60		nH
Module lead resistance, terminals-chip	$R_{\text{CC}'+\text{EE}'}$	$T_C=25^\circ\text{C}$, per switch		4.0		m Ω
	$R_{\text{AA}'+\text{CC}'}$			3.0		
Thermal Resistance Junction-to Case	$R_{\theta\text{JC}}$	per IGBT-inverter			0.52	K/W
		per Diode-inverter			0.81	
		per IGBT-brake-copper			0.66	
		per Diode-chopper			1.50	
		per Diode-rectifier			0.75	
Thermal Resistance Case-to Sink	$R_{\theta\text{CS}}$	per IGBT-inverter		0.31		K/W
		per Diode-inverter		0.48		
		per IGBT-brake-copper		0.33		
		per Diode-chopper		0.70		
		per Diode-rectifier		0.36		
		per Module		0.02		
Mounting Force Per Clamp	F		3.0		6.0	N
Weight of Module	G			180		g

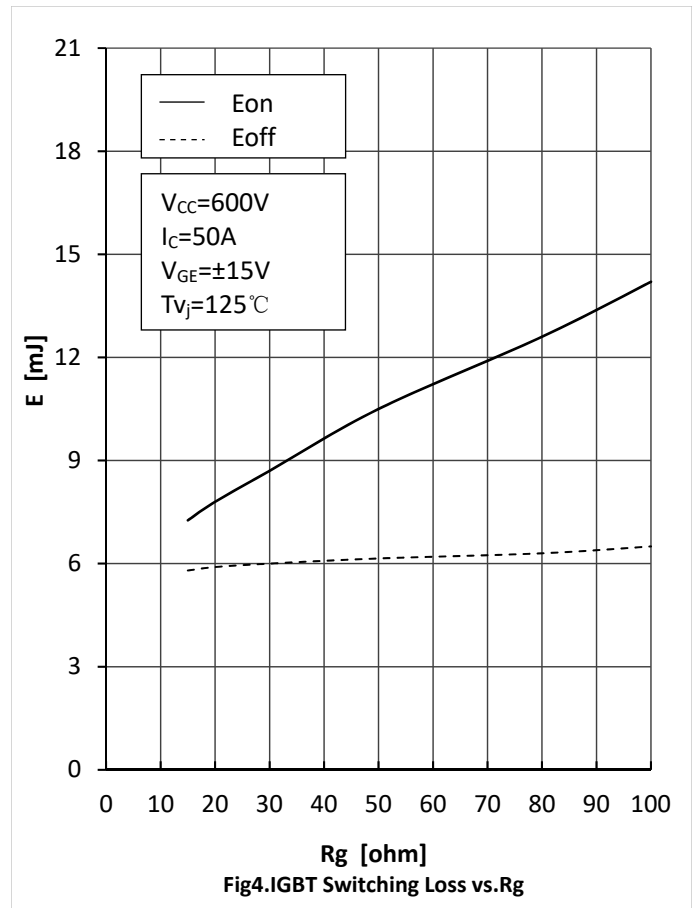
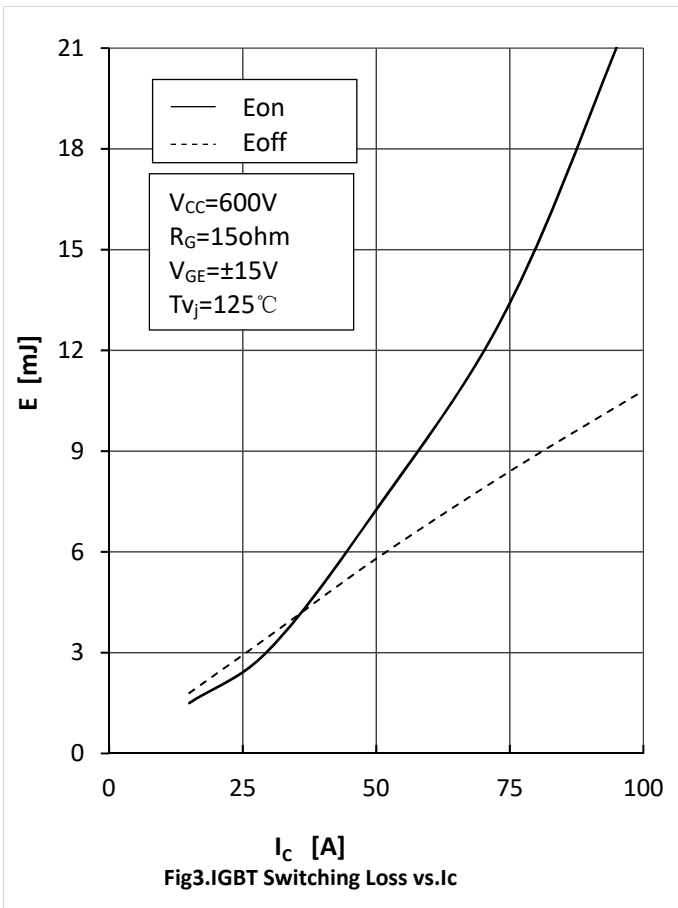
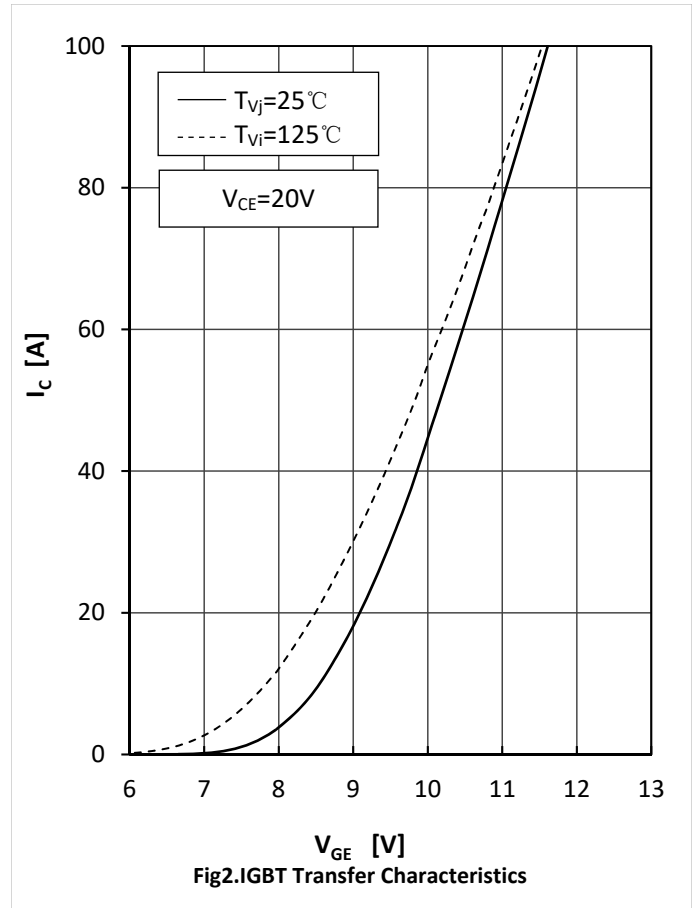
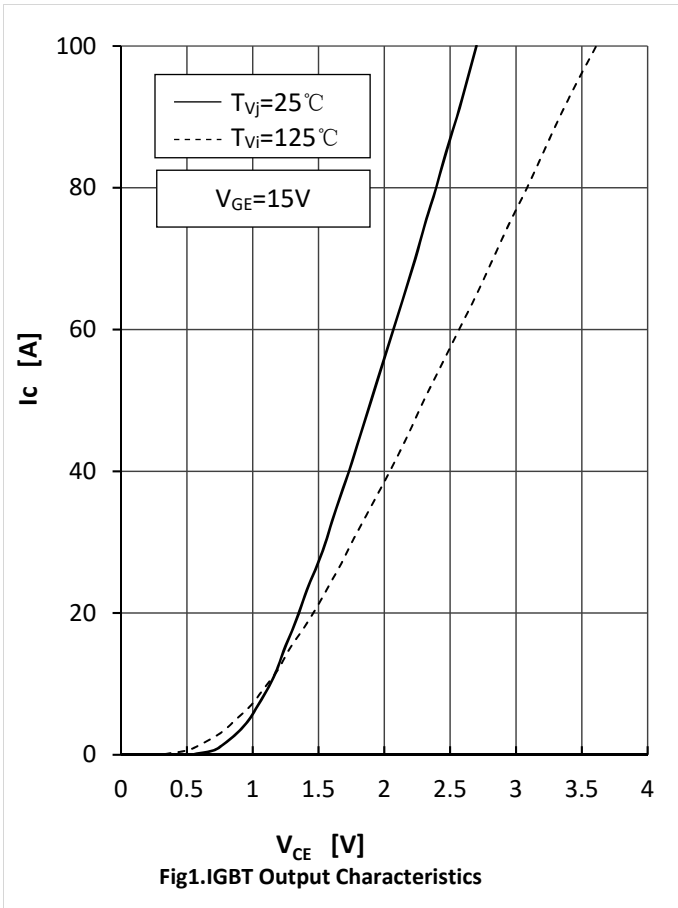

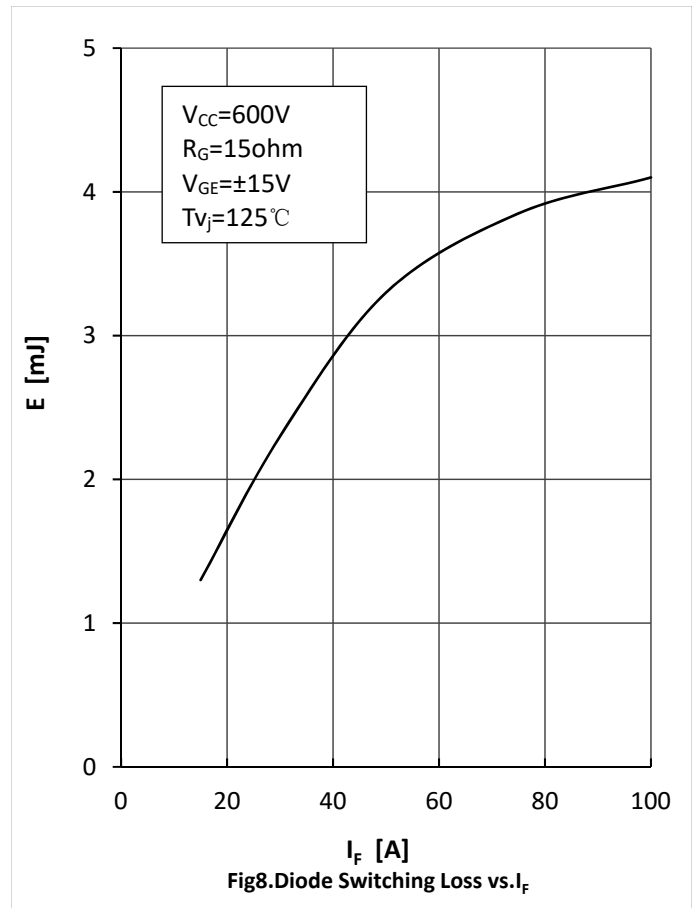
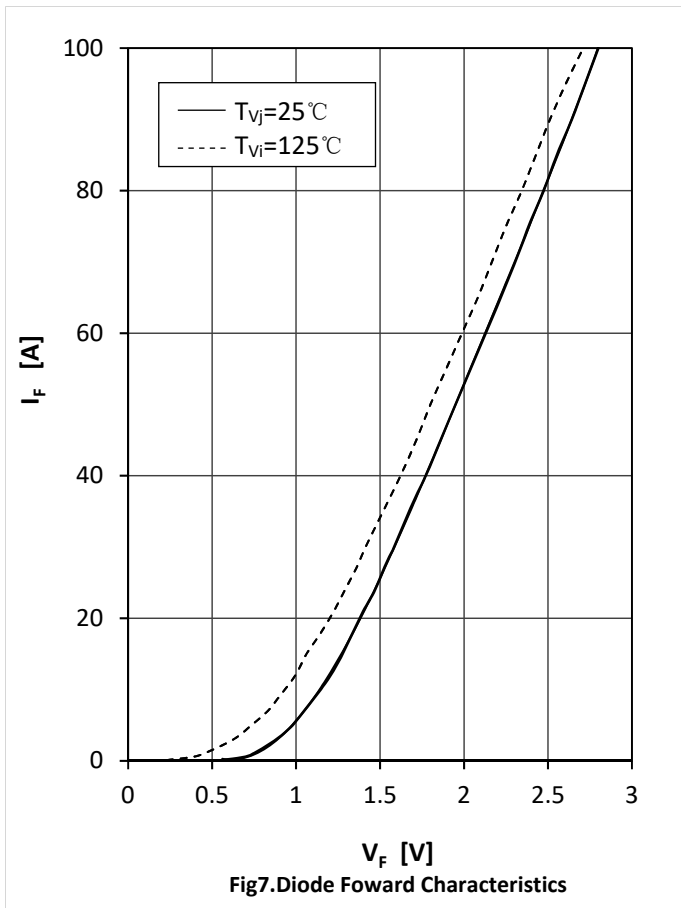
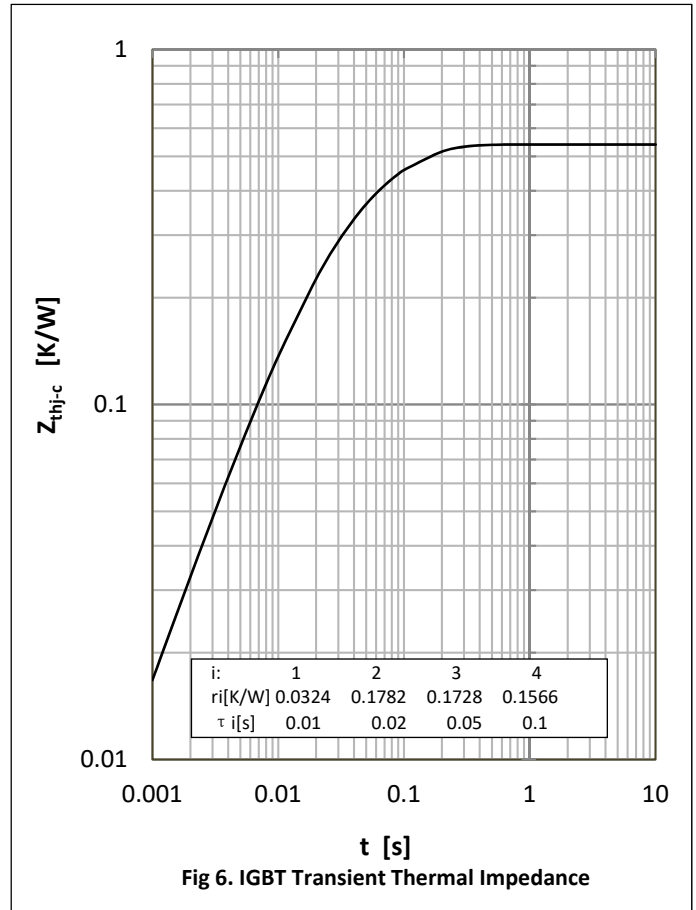
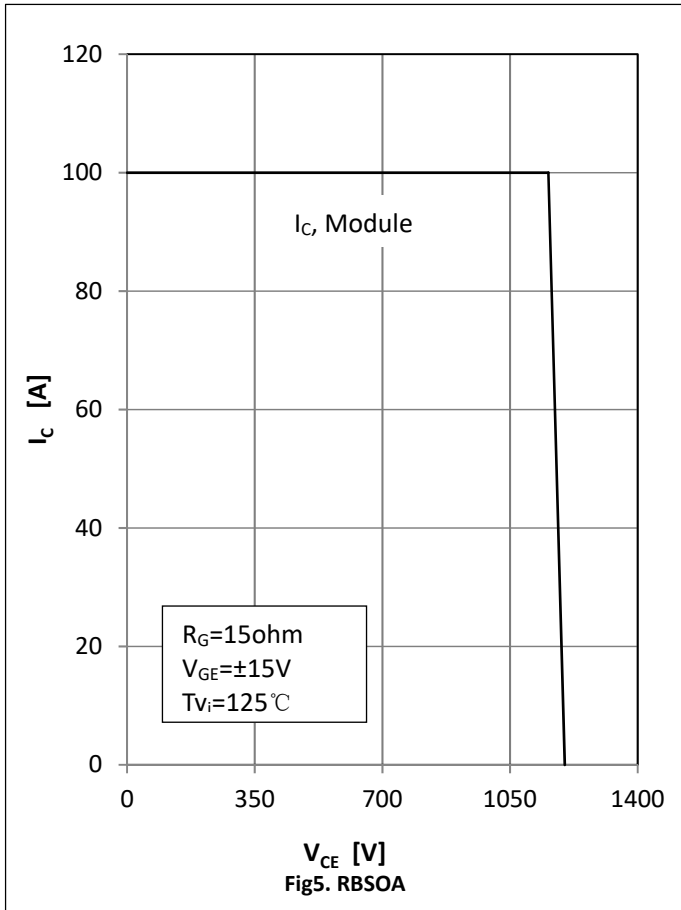

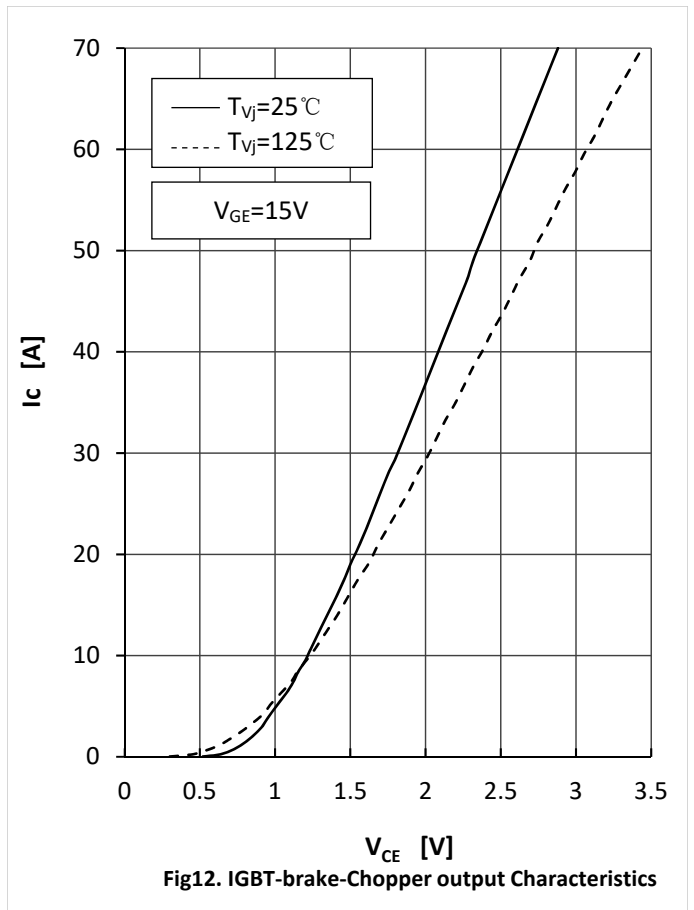
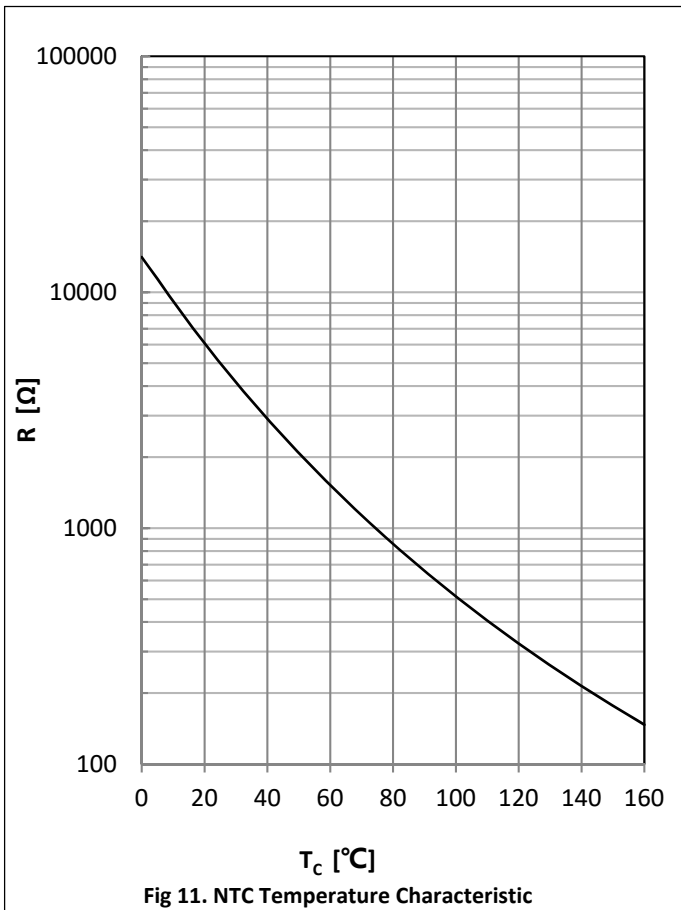
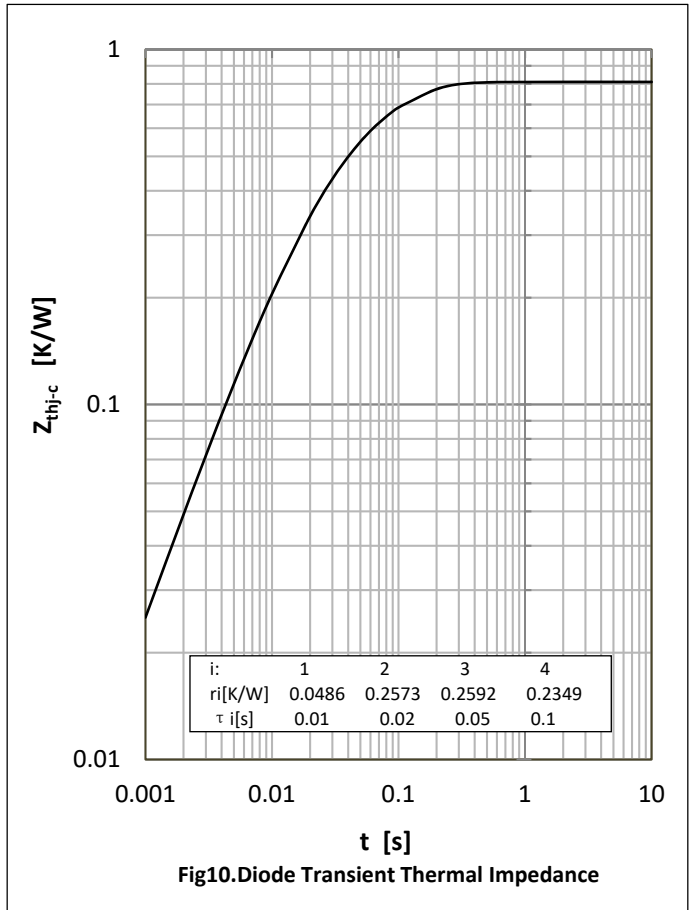
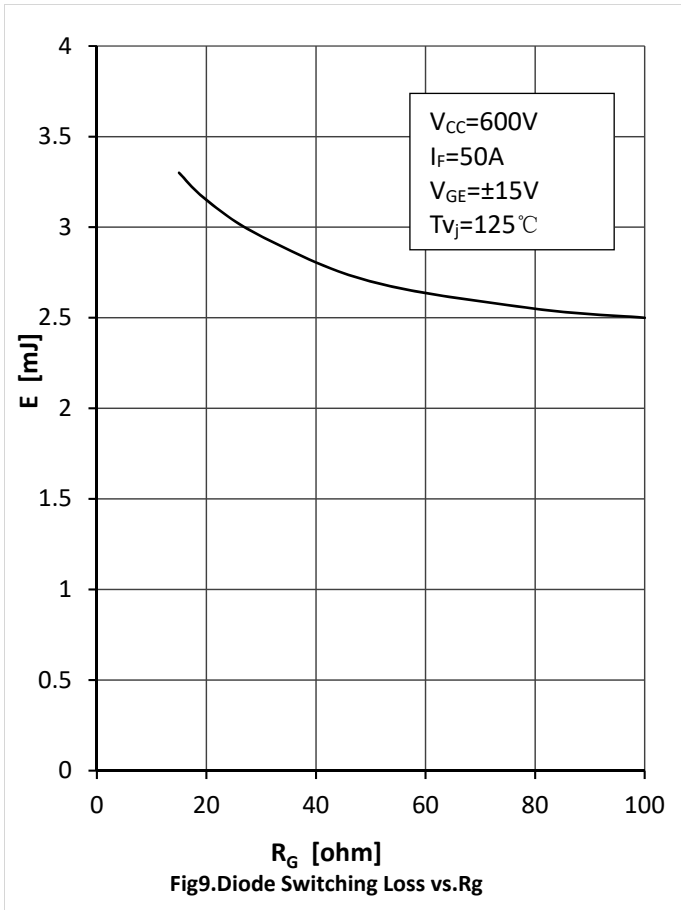

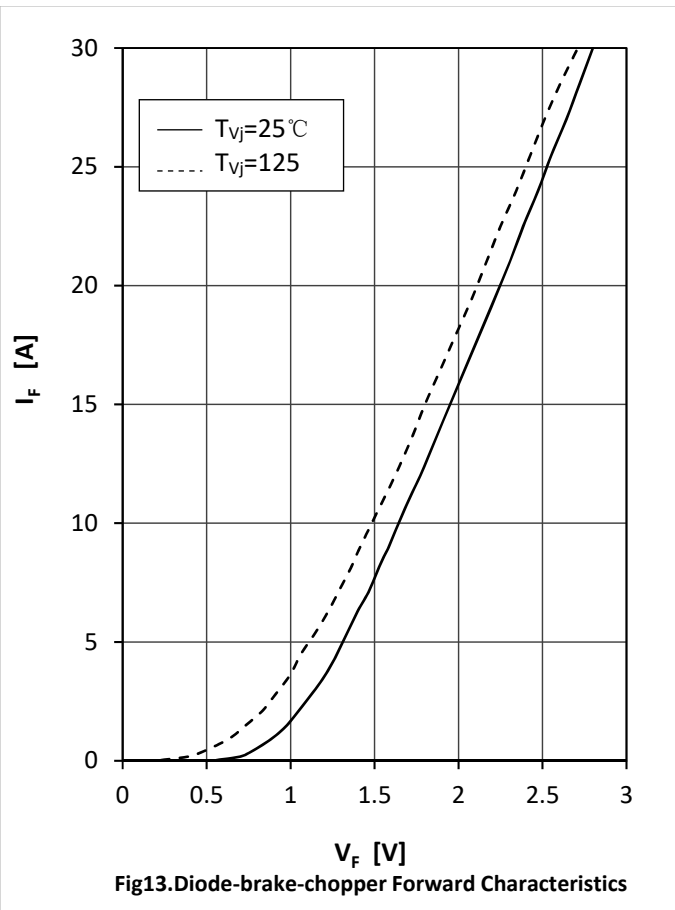



● Circuit Diagram

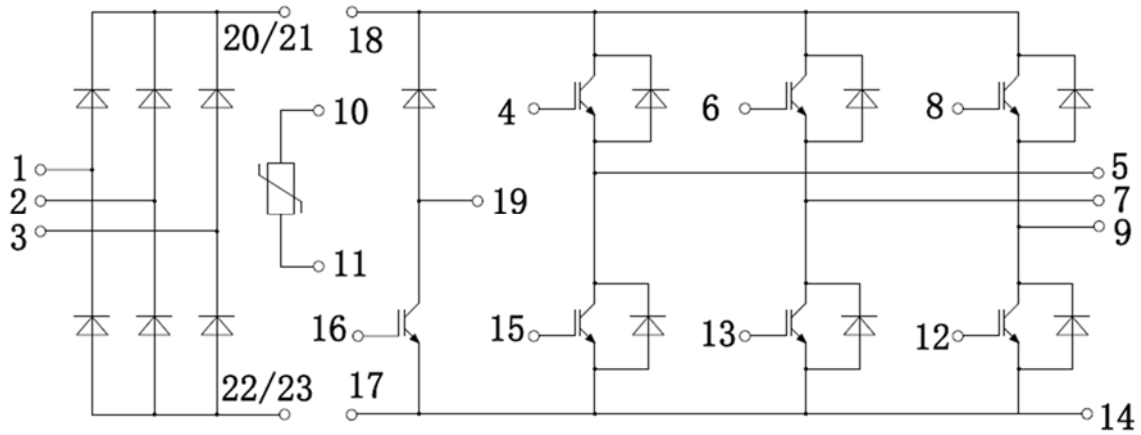

● Package Outline Information

